

Otto Bock®

QUALITY FOR LIFE



Nurmi Neo

Ⓓ	Bedienungsanleitung	3
ⒼⒹ USA	Instructions for Use	27



Instructions for Use for Nurmi Neo

Table of Contents	Page
1 General Information	28
1.1 <i>Preface</i>	28
1.2 <i>Intended Use</i>	28
1.3 <i>Liability</i>	28
1.4 <i>CE Conformity</i>	29
1.5 <i>Service</i>	29
2 Safety Instructions	30
2.1 <i>Explanation of Symbols</i>	30
2 <i>General Safety Instructions</i>	30
3 Unpacking and Setup	33
4 Adjustment and Adaptation Possibilities	36
4.1 <i>Height and Depth of the Grip Bar (all versions)</i>	36
4.2 <i>Standard Grip Bar</i>	36
4.3 <i>Grip Bar with Universal Grips</i>	36
4.4 <i>Mini Grip Bar (only available for model size 1)</i>	37
4.5 <i>Grip Bar, Extra High, with Channel Forearm Supports</i>	37
4.6 <i>Reverse-roll Lock</i>	38
4.7 <i>Folding for Transport</i>	38
5 Accessories	39
5.1 <i>Storage Basket</i>	39
5.2 <i>Driving Brake and Wheel Lock</i>	40
5.3 <i>Gluteal Support and Combined Gluteal and Pelvic Supports</i>	40
5.4 <i>Anti-tipper</i>	41
5.5 <i>Caster Swivel Lock</i>	42
5.6 <i>Friction Brake</i>	42
5.7 <i>Bench</i>	43
5.8 <i>Sling Seat</i>	43
6 Care Instructions	46
7 Technical Data	47
8 Information on Re-use	48

1 General Information

1.1 Preface

The Nurmi Neo Ergonomic Walker you have selected is a high-quality product from our company. This manual is intended to help you enjoy long, reliable service from this product as an invaluable aid in everyday life. It shows you how to use the product correctly, and briefly introduces you to the required care and maintenance. Please read carefully the following tips and instructions to get the most out of the product and to avoid any damage that might be caused by using it incorrectly. If you have any questions or problems, please contact your specialist dealer. We hope that you experience trouble-free use of this product and that it meets your expectations. We reserve the right to make technical changes to the design described in these instructions for use.

1.2 Intended Use

The Nurmi Neo Ergonomic Walker is a posterior walker. This means that the Nurmi Neo is not pushed in front of the user's body, as is the case with anterior walkers. Instead, it is moved behind the body. This ensures optimum forward mobility.

(Source: Catalogue of appliances and list of appliances of the health insurance companies, FRG)

The Nurmi Neo Ergonomic Walker helps children or adolescents use the strength and support of their upper extremities to assist their compromised lower extremities while walking. The walker is used to aid the child in learning the sequence of movements involved in walking and thus increase their range of action. It is also used for walking training in the case of diseases or injuries that involve both a disturbance in the locomotor system and imbalance/ asynergia.

The walker is designed to promote an active upright posture while standing and walking. As a result, it offers a walking concept for natural movements that differs from conventional walking aids. The Numi Neo is therefore much better suited to help the user learn to stand and walk and to develop his/her sense of balance.

1.3 Liability

The manufacturer's warranty applies only if the product has been used under the conditions and for the purposes described. The manufacturer recommends that the product be used and maintained according to the instructions for use.

The manufacturer is not responsible for damages caused by components and spare parts not approved by the manufacturer. Repairs must be carried out exclusively by authorized dealers or by the manufacturer.

1.4 CE Conformity

This product meets the requirements of the 93/42/EEG guidelines for medical products. This product has been classified as a class I product according to the classification criteria outlined in appendix IX of the guidelines. The declaration of conformity was therefore created by Otto Bock with sole responsibility according to appendix VII of the guidelines.

1.5 Service

Service and repairs on the Nurmi Neo Ergonomic Walker may only be carried out by Otto Bock specialist dealers. Should any problems arise, please contact the supplier of your Nurmi Neo Ergonomic Walker. Any necessary repairs will be made exclusively with authentic Otto Bock spare parts there.

The following tools are required for repair and maintenance:

Allen wrenches, sizes: 3 mm, 4 mm, 5 mm, and 6 mm

Wrenches, sizes: 10 mm, 13 mm, 17 mm, and 19 mm

Your authorised Otto Bock dealer:

2 Safety Instructions

2.1 Explanation of Symbols

⚠ WARNING Warnings regarding possible risks of severe accident or injury.

⚠ CAUTION Warnings regarding possible risks of accident or injury.

NOTICE Warnings regarding possible technical damage.

INFORMATION Information regarding operation. Information for service personnel.

2 General Safety Instructions

INFORMATION

Please read the Instructions for Use first! Before using the product, you should become familiar with the handling, function and use of the product. You are responsible for the safety of your child. You may compromise the safety of your child if you do not observe these instructions. However, it is impossible to protect against and avoid all unforeseeable circumstances and situations.

⚠ WARNING

Danger of suffocation. Make sure to keep packaging material away from children.

⚠ CAUTION

Danger as a result of failure to perform functional testing. In the interest of your child's safety, the correct function of the mobility base with seating shell is to be checked before every use.

⚠ CAUTION

Risk of falling. Nurmi Neo is a therapeutic appliance and may be used under supervision only. Never leave your child unattended.

Danger while driving/parking

⚠ CAUTION

Risk of accident as a result of improper use. The product may be used only on solid level ground.

⚠ CAUTION

Risk of tipping as a result of improper use. The grip bar may never be used as a seat surface.

⚠ CAUTION

Risk of tipping due to centre of gravity shifting. When your child reaches for objects in front, to the side or behind the walker, make sure that he or she does not lean out of it too far.

⚠ CAUTION

Risk of tipping caused by overload. Attaching heavy bags or other weight can adversely affect stability. Observe the maximum load for each model (refer to Technical Data).

⚠ CAUTION

Risk of pinching. While folding the Nurmi Neo, do not hold on to other parts than the ones described, especially the folding mechanism.

⚠ CAUTION

Risk of pinching. If the seat board is not properly locked in place, the fingers may be pinched between the seat board and frame.

Danger as a result of incorrect assembly or settings

⚠ CAUTION

Risk of injury as a result of incorrectly mounted grip bar. The maximum height setting of the grip bar is predetermined by an extension limit. Adjustments beyond this range are not permitted.

⚠ CAUTION

Risk of tipping when driving against obstacles without braking. Do not drive into obstacles (including steps, curbs) without braking.

⚠ CAUTION

Risk of tipping after height adjustment of the grip bar. After any height adjustment of the grip bar, the grip bar depth must be checked and corrected, if necessary. Otherwise the walker may tip over forwards.

⚠ CAUTION

Risk of tipping as a result of incorrect adjustment of grips/forearm supports. Setting the adjustable grips/forearm supports outwards beyond the grip bar is not permitted.

⚠ CAUTION

Risk of injury as a result of the grip bar sliding off. The grip bar must always be locked by closing the eccentric lever, even with engaged tripod springs in the maximum height position.

INFORMATION

All adjusting levers are fastened finger-tight without using tools.

INFORMATION

Make sure to firmly retighten all screws and nuts after making adjustments.

Danger as a result of improper condition of the tyres

⚠ CAUTION

Risk of falling as a result of worn-out tyres. Longer use leads to wear out of the tyres which results in reduced braking effect and danger of rolling away. Regularly check brakes for proper function and correct if necessary. Worn-out or damaged wheels must be replaced.

Danger caused by fire/heat

⚠ CAUTION

Risk of burns when near to fire. The sling seat may catch fire. Keep the walker away from all sources of ignition, especially lit cigarettes.

Warnings regarding damage to the walker

⚠ CAUTION

Risk of falling caused by overload. In case the seating unit is overloaded above the specified load capacity, the connection elements may break and, as a result, lead to the falling of your child. The maximum load capacity (payload) of the seating unit/Sling Seat is 25 kg (size 1), 40 kg (size 2), 55 kg (size 3).

NOTICE

Damage caused by incorrect packaging. Only use original packaging for shipment of the product.

NOTICE

Damage caused by objects lying upon the appliance. If appliances are transported in the folded state, the weight of objects lying upon the appliance can cause deformations and result in problems when unfolding the appliance. Never put heavy objects on a folded rehabilitation device.

NOTICE

Damage caused by incorrect packaging. Only use original packaging for shipment of the product.

3 Unpacking and Setup

In the original package you will find the following components:

- Base frame, folded
- Grip bar
- Accessories as ordered (partially pre-assembled)

To set up the Nurmi Neo Ergonomic Walker, proceed as follows:

- First, carefully remove the transport locks and the packaging and put the components on the floor (Fig. 1).
- Take hold of the base frame behind the front wheels (Fig. 2) and unfold the base frame as shown in the photo.



- Once the frame has been unfolded, tighten the star grips (Fig. 3) on both sides.
- Unfold the grip bar (Fig. 4) and insert the grip bar into the unfolded base frame (Fig. 5).
- Press down the tripod spring buttons (extension limit) while pushing in the grip bar. Insert the grip bar into the frame until the extension limits on the left and right side have engaged (Fig. 6).





⚠ CAUTION

Risk of injury as a result of incorrectly mounted grip bar. The maximum height setting of the grip bar is predetermined by an extension limit. Adjustments beyond this range are not permitted.

⚠ CAUTION

Risk of tipping as a result of incorrect adjustment of grip bar depth. The grip bar depth must always be within the defined range behind the swivel lock housing. Please observe the following instructions.

- Adjust the grip bar to the desired height and close the eccentric lever (Fig. 7) on both sides of the base frame.
- With the eccentric lever in the open position, the clamping force of the lever can be adjusted by turning the knurled nut (Fig. 8). When correctly adjusted, you must be able to snugly tighten the eccentric lever with a great amount of manual force.
- After closing the eccentric levers, test the firm seat of the grip bar. It must not be possible to push in the grip bar with standard load. Otherwise, with the eccentric lever in the open position, the clamping force of the lever must be increased by turning the knurled nut clockwise (Fig. 8).



⚠ CAUTION

Risk of injury as a result the grip bar sliding off. The grip bar must always be locked by closing the eccentric lever, even with engaged tripod springs in the maximum height position.

- Finally, adjust the depth of the grip bar evenly on both sides and tighten the clamping screws (Fig. 9) on both sides.

The depth of the grip bar must be set so that the anterior edge of the grips on the grip bar lies behind the caster swivel lock housings by the length of **A**. When using channel forearm supports, the anterior edge of the supports must lie behind the caster swivel lock housings by the length of **A**.

Minimal length of A when using....	With Nurmi-Neo, size 1	With Nurmi-Neo, size 2	With Nurmi-Neo, size 3
...standard grip bar...	11 cm	15 cm	19 cm
...grip bar with universal grips...	11 cm	15 cm	19 cm
...mini grip bar...	11 cm	15 cm	19 cm
...grip bar, extra high, with channel forearm supports...	18 cm	20 cm	22 cm

It is best to check this (Fig. 10) by placing the caster swivel lock housings of the Nurmi Neo against a smooth door and measuring the space from the door's surface to the grip or forearm support.

For this check, the entire caster swivel lock housings must be slid onto the front frame and the casters turned to the side.

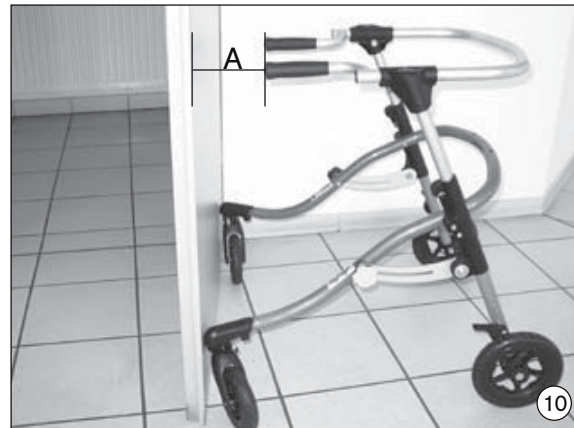

⚠ CAUTION

Risk of tipping after height adjustment of the grip bar. After any height adjustment of the grip bar, the grip bar depth must be checked and corrected, if necessary. Otherwise the walker may tip over forwards

4 Adjustment and Adaptation Possibilities

4.1 Height and Depth of the Grip Bar (all versions)

The height and depth of the grip bar (Fig. 11 and 12) can be adjusted (refer to "Unpacking and Setup").

4.2 Standard Grip Bar

Shown here (Fig. 11 and 12)



4.3 Grip Bar with Universal Grips

After loosening the screw connections, you can rotate both grips (Fig. 13), thereby adjusting the distance between the grips as well as the grip height (refer to Technical Data). However, the grips may only be adjusted within the range shown here (Fig. 14). After adjustment, snugly retighten the screw connections.



⚠ CAUTION

Risk of tipping as a result of incorrect adjustment of grips. Setting the adjustable grips outwards beyond the grip bar is not permitted.

4.4 Mini Grip Bar (only available for model size 1)

Mini hand grips (Fig. 15) make especially low grip heights and short distances between the grips possible. Adjust the grips as described under Universal Grips. Swinging the grips upwards is not permitted.

⚠ CAUTION

Risk of tipping as a result of incorrect adjustment of grips. Swinging the grips upwards is not permitted.

4.5 Grip Bar, Extra High, with Channel Forearm Supports

The channel forearm supports with vertical hand grips have been designed for users who are unable to support themselves on their extended arms and who feel safer using their forearms for support.

Height adjustment of the channel forearm supports and the vertical grips is realised along with the height adjustment of the grip bar. After opening the screw connection (Fig. 17, item B), the angle and depth of the grip (Fig. 17, item A) can be adjusted. The depth of the channel forearm support can also be changed after removing the detachable pad (Fig. 16, item A) and loosening the screw connection (Fig. 16, item B). The distance between the forearm support and grip should be adjusted so as to avoid pressure points and cramped postures. After opening the clamp connection (Fig. 17, item C), the space between the two channel forearm supports can be adjusted (refer to Technical Data). However, the grips/forearm supports may only be adjusted within the range shown here (Fig. 18). An abducted setting of the arm supports is also possible. After adjustment, snugly retighten the screw connections.

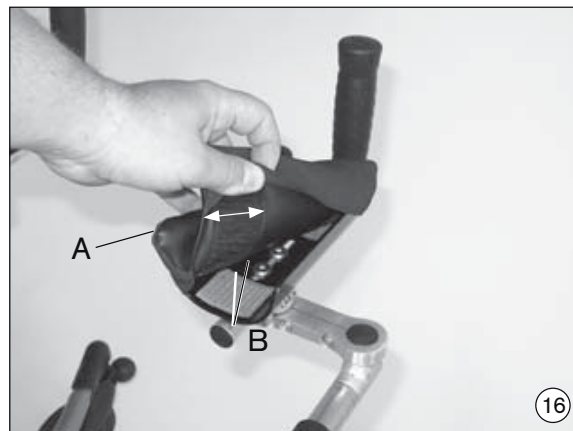

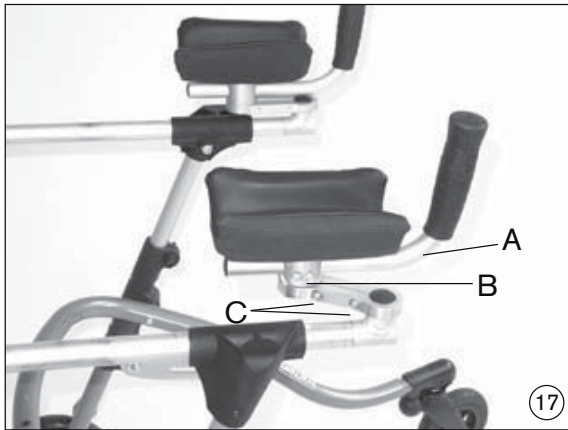

⚠ CAUTION

Risk of tipping as a result of incorrect adjustment of grips/forearm supports. Setting the adjustable grips/forearm supports outwards beyond the grip bar is not permitted.

4.6 Reverse-roll Lock

⚠ CAUTION

Risk of injury caused by malfunction of the reverse-roll lock. Regularly check the reverse-roll lock for proper function and correct if necessary. Worn-out or damaged wheels must be replaced.

Children instinctively tend to fall backwards. For this reason, the Nurmi Neo is equipped with reverse-roll locks (Fig. 19) and thus provides optimum support.

If you want to make the reverse-roll lock inoperative, press and flip up the locks (Fig. 20). This makes it possible to freely move the walker forward and backward.



4.7 Folding for Transport

Before folding, loosen the star grips (Fig. 21) on both sides of the front frame until you can loosen the folding levers from the folding guards by pushing outwards.

Take hold of the walker's hand grips and lift the walker or tip it over the rear wheels. The anterior frame will fold in (Fig. 22). Tighten the star grips to secure the folded walker against unintended unfolding.

You will achieve an especially small folding size if you detach and fold the grip bar. To do this, proceed as described under "Unpacking and Setup" but in the reverse order.



⚠ CAUTION

Risk of pinching. While folding the Nurmi Neo, do not hold on to other parts than the ones described, especially the folding mechanism.

5 Accessories

Any accessory not installed by the manufacturer must be installed by a qualified technician.

5.1 Storage Basket

Apart from practical use, the storage basket can be used for therapeutic purposes, e.g. to provide a stimulus for the patient to collect things.

The basket (Fig. 23) is attached to the grip bar and can be removed by means of a quick-release lock. Depending on the accessories being used (gluteal support, for example), the basket can be attached in the centre or laterally shifted. A lock against rotation (Fig. 24) of the quick-release lock must be attached to the grip bar.

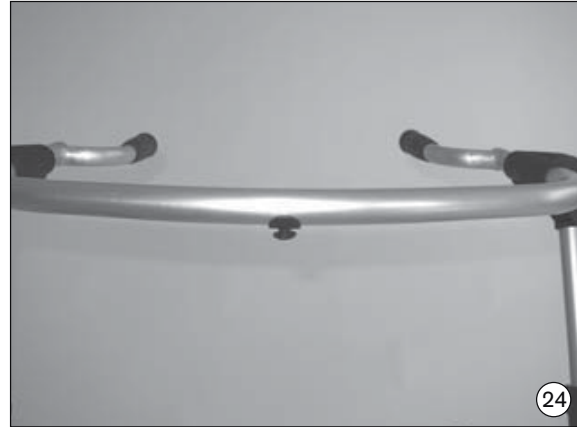

5.2 Driving Brake and Wheel Lock

⚠ CAUTION

Risk of injury due to brake failure. Regularly check the wheel lock for proper function and correct if necessary. Worn-out or damaged wheels must be replaced.

The wheel lock allows the patient to both control braking and to park the Nurmi Neo safely. To lock the brakes, pull the brake handle (Fig. 25) completely and engage the retaining claw with your index finger. To release the wheel lock, pull the brake handle slightly so that the retaining claw will open. If the braking function is insufficient, readjust the respective brake cable with the adjustment screw (Fig. 26).

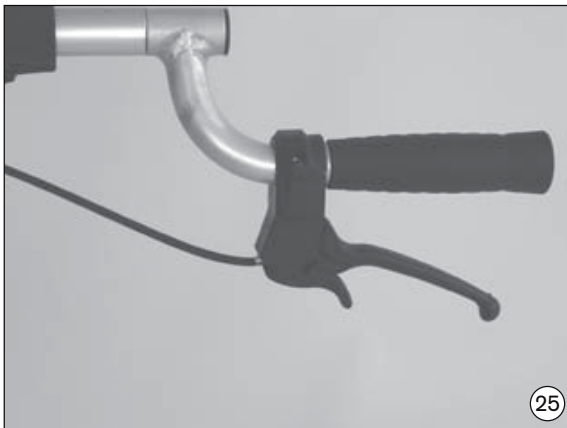

5.3 Gluteal Support and Combined Gluteal and Pelvic Supports

The gluteal support (Fig. 27) as well as the combined gluteal and pelvic supports (Fig. 28) make it possible for the user to position him- or herself optimally in the grip bar area. Since many users tend to support themselves to the rear, these supports bring the user once again into the anterior area of the grip bar and thereby into an upright position. The pad of the gluteal support is approx. 30 cm wide and slightly shaped like a shell. The angle can be adjusted. The width and

angle of the pelvic supports (Fig. 28, item D) of the combined gluteal and pelvic supports can also be adjusted. The centre pad (Fig. 28, item E) can be removed if especially narrow settings are required or desired.

The gluteal supports can be adjusted in three dimensions:

- The screw connection (Fig. 27+ 28, item A) on the clamp attachment allows an adjustment in depth.
- The height can be adjusted by turning the clamp attachment (Fig. 27+ 28, item B) and the supports (Fig. 27+ 28, item C).
- The angle of the supports can be adjusted after opening the clamp (Fig. 27+ 28, item C).

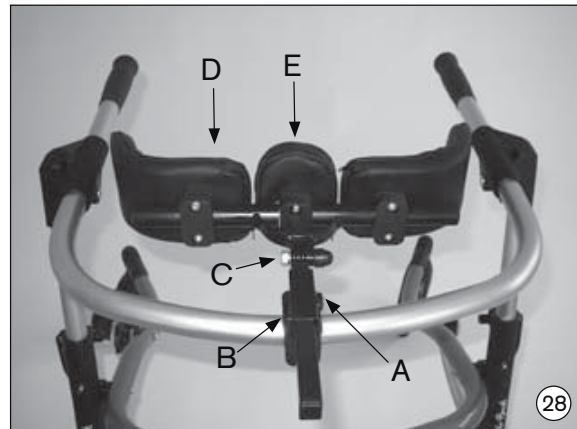
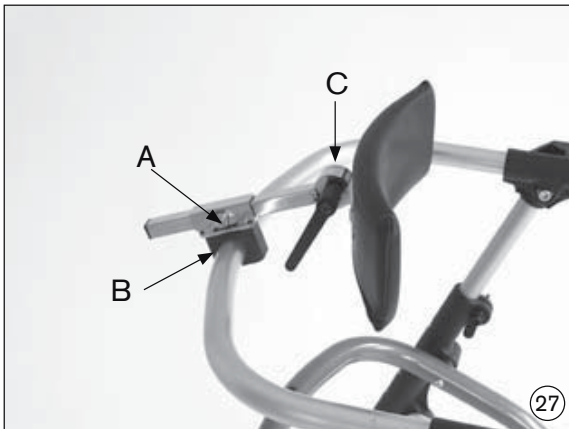

5.4 Anti-tipper

The anti-tipper increases stability against tipping backward and is offered for every model size.

The anti-tipper bows are inserted into the anti-tipper holders (Fig. 29) and secured with tripod springs against turning. The anti-tipper bows (Fig. 30) can be swung upwards.



5.5 Caster Swivel Lock

The caster swivel lock is especially suited for the initial phase of therapy with Nurmi Neo models, since greater manoeuvrability also requires increased coordination ability on the part of the user. The caster swivel lock can be used to fix the swivelling front wheels. To lock the front wheel forks, pull the swivel lock housing to the front until the housing encloses the cap nut (Fig. 31). To open the caster swivel lock, slide the swivel lock housing away from the wheel until the cap nut is free. If necessary, the setting for straight-forward motion can be re-adjusted. To do this, loosen the screw until the screw can be shifted in the slotted hole. Now close the swivel lock, set the front wheel so that it is positioned for straight-forward motion and slightly tighten the screw using a 10 mm open-end wrench. Open the swivel lock, turn the wheel to the outside (Fig. 32) and firmly tighten the screw with two open-end wrenches. Retrofitting with a caster swivel lock can only be carried out by the specialist dealer.



5.6 Friction Brake

⚠ CAUTION

Risk of injury due to brake failure. Regularly check the the friction brake for proper function and correct if necessary. Worn-out or damaged wheels must be replaced.

The friction brake can be used to control deceleration. The pressure of the friction brakes on the hub and thus the rolling speed of the tyres can be varied by loosening or tightening the interior set screws (Fig. 33).

5.7 Bench

⚠ CAUTION

Risk of falling caused by overload. The maximum load capacity (payload) of the seating unit is 25 kg (size 1), 40 kg (size 2), 55 kg (size 3).

The bench (Fig. 34) is not designed to be a comfortable piece of furniture but a simple and practicable auxiliary seat which enables the user to rest every now and then while using the Nurmi Neo. The seat is located in the upright position while walking and simply folded down for use.

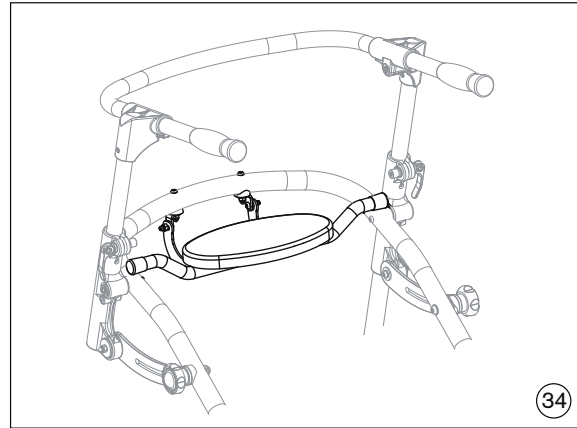

5.8 Sling Seat

⚠ CAUTION

Risk of falling caused by overload. The maximum load capacity (payload) of the Sling Seat is 25 kg (size 1), 40 kg (size 2), 55 kg (size 3).

The Sling Seat (Fig. 35: Attached to the Nurmi neo; Fig. 36: Top view) serves to effectively support the user during gait training. Children can rest at any time and are protected against falls in case of sudden fatigue or insecurity.

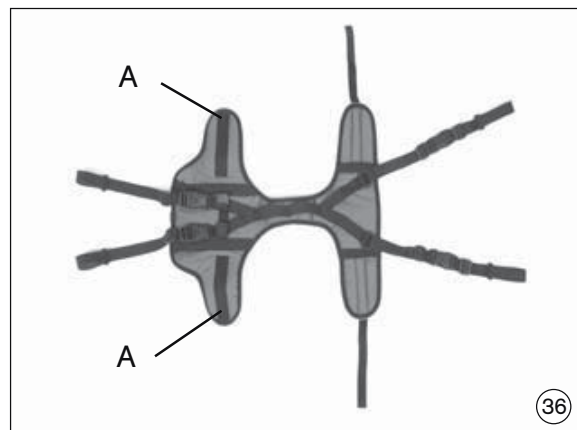
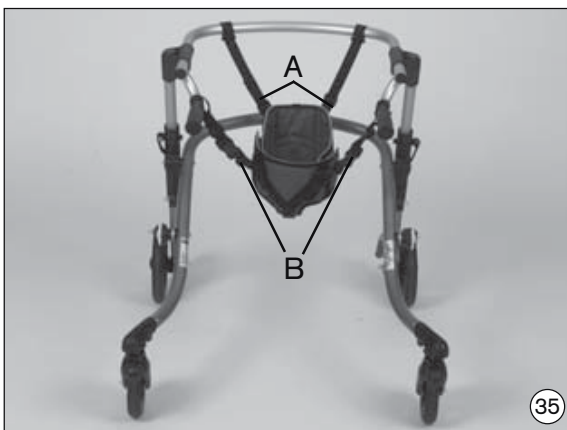

The Sling Seat is attached to the Nurmi Neo with four length adjustable straps (Fig. 35, items A/B). Plastic buckles allow to easily detach the Sling Seat from the straps. The rear straps have safety buckles which are to be opened with both hands (Fig. 35, item A). The front straps feature standard buckles (Fig. 35, item B).

When using the grip bar with universal grips/mini hand grips/hand grips with channel forearm supports, proceed as follows to mount the Sling Seat:

INFORMATION

Make sure to attach the straps without becoming twisted and that the rubber-coated inner side of the loops rest on the metal to prevent slipping.

- First disassemble the hand grips (Fig. 37) and the grip bar (Fig. 38).



- Then slip the loop of the rear straps with the rubber coating on the inner side over the grip bar (Fig. 39) and reattach the grip bar and the hand grips.
- Next, slip the loops of the front straps over the hand grips (Fig. 40) and close the hook and loop closures of the Sling Seat (Fig. 36, item A).



To adjust the height of the Sling Seat using the strap tighteners, please observe the following: With taut straps, your child should stand firmly and safely with both soles on the ground. Proceed as follows:

- First measure the leg length of your child.
- Use the strap tighteners on the four straps to adjust the height. Thread the free strap ends out of the strap tighteners and move the straps through the standard buckles / safety buckles to the appropriate height (Fig. 40). Fix the strap at this height by threading it back through the strap tightener. Correct, if necessary.
- To use the Sling Seat, please observe the following:
- Place your child over the opened Sling Seat and tightly close it using the lateral hook and loop closures (Fig. 36, item A).
- If necessary, correct the height adjustment using the strap tighteners.
- To prevent sudden opening of the Sling Seat, please always close the two strap clamps on the back (Fig. 41).

⚠ CAUTION

Risk of falling as a result of sudden opening of the strap clamps. Never forget to close the two strap clamps on the back of the Sling Seat.

INFORMATION

In the front, the height of the Sling Seat can be very flexibly adjusted using four strap tighteners.

When using a standard grip bar (Fig. 11/12), there is a significant difference to be observed for mounting the rear straps:

- Since the hand grips are not detachable, you must open the attachment loops of the rear straps (Fig. 42, item A) to be able to lay them around the cross section of the grip bar.

INFORMATION

Do the following steps on only one strap first. In this way, you always have a fully mounted strap as an example.

- Thread the free strap end (Fig. 42, item A) out of the strap tightener (Fig. 42, item B) and then out of the safety buckle (Fig. 42, item C).
- Pull the strap tightener off the strap and completely open the attachment strap. Lay the free strap end around the cross section of the grip bar and close the attachment loop.
- Finally, reassemble the strap in reverse order.

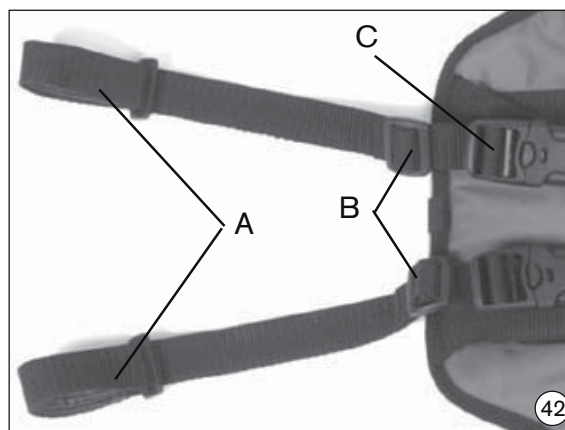

6 Care Instructions

NOTICE

Damage caused by improper cleaning agents. Clean all frame components, artificial leather and plastic parts using only standard household cleaning agents. Please observe the following instructions for care.

Your Nurmi Neo has been provided with the CE sign. The manufacturer herewith guarantees that this medical product as a whole conforms to the requirements of the European Directive for Medical Products 93/42/EEC. The correct function of the walking aid must be checked before every use. The following table lists functions which the user must check at the indicated intervals.

To be checked before use	daily	weekly	monthly
Firm seat of the grip bar	X		
Function test of the reverse-roll lock	X		
Screw connections		X	
Visual examination of wearing parts, for example wheels and bearings			X
Dirt on bearings			X

Should any defects become apparent, please contact your authorised dealer to eliminate them. We also recommend that you have the product serviced every twelve months by your authorised dealer.

- Clean all frame components and plastic parts using mild detergents only.
- Do not use in salt water.
- Keep sand or other particles from damaging the wheel bearings.
- The Sling Seat can be washed at 30°C. If washed in a washing machine, put it in a laundry bag or a pillow case. In most cases, wiping with a damp cloth is sufficient.

7 Technical Data

Dimensions (cm) and weights (kg)	Size 1	Size 2	Size 3
Models	HR24160000	HR24260000	HR24360000
Grip height: Standard grip bar	45 – 57	58 – 72	64 – 85
Distance between grips: Standard grip bar	41	46	51
Grip height: Grip bar with universal grips	38 – 57	51 – 72	57 – 85
Distance between grips: Grip bar with universal grips	27 – 41	32 – 46	37 – 51
Grip height: Mini grip bar	31 – 48		
Distance between grips: Mini grip bar	20 – 41		
Grip diameter	3	3	3
Height of the channel forearm supports from the floor	53 – 75	68 – 91	71 – 95
Measurement from mid forearm support to mid forearm support	25 – 41	30 – 46	35 – 51
Support width x support length (inside)	7 x 16	7 x 21	7 x 21
Overall width	63	68	72
Overall length (with anti-tipper +10 cm)	65	76	83
Folding size (L x W x H)	65 x 63 x 24	76 x 68 x 24	85 x 72 x 24
Front wheel diameter	15	15	15
Rear wheel diameter	15	20	20
Load capacity	25	40	55
Weight	5,5	6	6,5
Seat height	30	45	48
Turning diameter (without accessories) EN 11199	86	99	106

8 Information on Re-use

⚠ CAUTION

Risk due to improper use. Seat paddings which come into direct contact with the skin may cause functional or hygienic risks for another patient using one and the same product. They must be replaced for re-use.

The product is suitable for re-use.

Similar to second-hand machines or cars, products that are being re-used are subject to increased strain. Features and functions must not change in a way that could endanger patients or other persons within the product's life cycle.

Based on market observations and the current state of technology, the manufacturer has calculated that the product can be used for a period of **4 years**, provided that it is used properly and that the service and maintenance instructions are observed. Periods during which the product is stored at the dealer or with the third party payer are not included in this period. It should be clearly pointed out, however, that the product is reliable far beyond this defined period of time, provided that it is cared for and maintained appropriately.

In cases of re-use, the corresponding product must first be thoroughly cleaned and disinfected. Subsequently, the product must be examined by an authorized specialist to check the condition, wear, and possible damages. Any worn and damaged components as well as components which do not fit or are not suitable for the user must be replaced.

The service manual includes a service schedule, detailed information, and a list of the required tools.

Kundenservice/ Customer Service

Europe

Otto Bock HealthCare Deutschland GmbH
Max-Näder-Str. 15 · D-37115 Duderstadt
Tel. +49 5527 848-3433 · Fax +49 5527 848-1460
e-mail: healthcare@ottobock.de · www.ottobock.com

Otto Bock Healthcare Products GmbH
Kaiserstraße 39 · A-1070 Wien
Tel. +43 1 5269548 · Fax +43 1 5267985
e-mail: Vertrieb.austria@ottobock.com
www.ottobock.at

Otto Bock Suisse AG
Pilatestrasse 2, Postfach 87 · CH-6036 Dierikon
Tel. +41 41 4556171 · Fax +41 41 4556170
e-mail: suisse@ottobock.com

Otto Bock Healthcare plc
32, Parsonage Road · Englefield Green
GB-Egham, Surrey TW20 0LD
Tel. +44 1784 744900 · Fax +44 1784 744901
e-mail: bockuk@ottobock.com · www.ottobock.co.uk

Otto Bock France SNC
4 Rue de la Réunion · B.P. 11
F-91941 Les Ulis Cedex
Tél. +33 1 69188830 · Fax +33 1 69071802
e-mail: information@ottobock.fr · www.ottobock.fr

Otto Bock Italia S.R.L.
Via Filippo Turati 5/7 · I-40054 Budrio (BO)
Tel. +39 051 692-4711 · Fax +39 051 692-4720
e-mail: info.italia@ottobock.com · www.ottobock.it

Otto Bock Iberica S.A.
C/Majada, 1 · E-28760 Tres Cantos (Madrid)
Tel. +34 91 8063000 · Fax +34 91 8060415
e-mail: info@ottobock.es · www.ottobock.es

Indústria Ortopédica Otto Bock Unip. Lda.
Av. Miguel Bombarda, 21 · 2º Esq.
P-1050-161 Lisboa
Tel.: +351 21 3535587 · Fax: +351 21 3535590
e-mail: ottobockportugal@mail.telepac.pt

Otto Bock Benelux B.V.
Ekkersrijt 1412 · NL-5692 AK-Son en Breugel
Tel. +31 499 474585 · Fax +31 499 476250
e-mail: info.benelux@ottobock.com
www.ottobock.nl

Otto Bock Scandinavia AB
Koppargatan 3 · Box 623 · S-60114 Norrköping
Tel. +46 11 280600 · Fax +46 11 312005
e-mail: info@ottobock.se · www.ottobock.se

Otto Bock Russia
5. Danskoj proezd 15, strojenie 16
RUS-119334 Moskau
Tel. +7 495 564-8360 · Fax +7 495 564-8363
e-mail: info@ottobock.ru · www.ottobock.ru

Otto Bock Hungária Kft.
Tatai út 74. · H-1135 Budapest
Tel. +36 1 4511020 · Fax +36 1 4511021
e-mail: info@ottobock.hu · www.ottobock.hu

Otto Bock Polska Sp. z o. o.
Ulica Korolowa 3 · PL-61-029 Poznań
Tel. +48 61 6538250 · Fax +48 61 6538031
e-mail: ottobock@ottobock.pl · www.ottobock.pl

Otto Bock ČR s.r.o.
Protetická 460 · CZ-33008 Zruč-Senec
Tel. +420 37 7825044 · Fax +420 37 7825036
e-mail: email@ottobock.cz · www.ottobock.cz

Otto Bock Slovakia s.r.o.
Čajáková 25 · SK-81105 Bratislava 1
Slovenská Republika
Tel./Fax +421 2 52 44 21 88
e-mail: info@ottobock.sk · www.ottobock.sk

Otto Bock Romania srl
Șos de Centura Chitila-Mogoșoia Nr. 3
RO-Chitila 077405, Jud. Ilfov
Tel: +40 21 4363110 · Fax: +40 21 4363023
e-mail: Ionut.savescu@ottobock.ro · www.ottobock.ro

Otto Bock Adria D.O.O.
Dr. Franje Tudmana 14 · HR-10431 Sveta Nedelja
Tel. +385 1 3361544 · Fax +385 1 3365986
e-mail: info@ottobock.hr · www.ottobock.hr

Otto Bock Adria Sarajevo D.O.O.
Omladinskih radnih brigada 5 · BIH-71000 Sarajevo
Tel. +387 33 766200 · Fax +387 33 766201
obadria@bih.net.ba · www.ottobockadria.com.ba

Otto Bock Sava d.o.o.
Maksima Gorkog bb · 18000 Niš, Republika Srbija
Tel./Fax +381 18 539 191
e-mail: info@ottobock.rs · www.ottobock.rs

Otto Bock Ortopedi ve Rehabilitasyon Tekniği Ltd. Şti.
Ali Dursun Bey Caddesi · Lati Lokum Sokak
Meriç Sitesi B Blok No: 6/1
TR-34387 Mecidiyeköy-İstanbul
Tel. + 90 212 3565040 · Faks +90 212 3566688
e-mail: info@ottobock.com.tr · www.ottobock.com.tr

Otto Bock Algérie E.U.R.L.
32, rue Ahcène outalab · Coopérative les Mimosas
Mackle-Ben Aknoun · Alger · DZ-Algérie
Tel. + 213 21 913863 · Fax + 213 21 913863
e-mail: information@ottobock.fr · www.ottobock.fr

Otto Bock Orthopedic Services S.A.E.
115 El · Alameen St. · Mohandessein – Giza
Tel. +20 23 3024390 · Fax +20 23 3024380
e-mail: info@ottobock.com.eg · www.ottobock.com

Americas

Otto Bock Argentina S.A.
Piedras, 1314 · Código Postal:
RA-1147 Ciudad Autónoma de Buenos Aires
Tel. + 54 11 4300 0076
e-mail: ventas@ottobock.com.ar

Otto Bock do Brasil Ltda.
Rua Jovelino Aparecido Miguel, 32
BR-13051-030 Campinas-São Paulo
Tel. +55 19 3729 3500 · Fax +55 19 3269 6061
e-mail: ottobock@ottobock.com.br · www.ottobock.com.br

Otto Bock Healthcare Canada Ltd.
5045 S. Service Road
Burlington Ontario L7L 5Y7
Tel. +1 800 665 3327 · Fax +1 800 463 3659
e-mail: info@ottobock.ca · www.ottobock.ca

Otto Bock HealthCare Andina Ltda.
Clínica Universitaria Teletón, Autopista Norte km 21
La Caro · Chia, Cundinamarca
Bogotá / Colombia
Tel. +57 1 8619988 · Fax +57 1 8619977
e-mail: ottobock@telesat.com.co

Otto Bock de Mexico S.A. de C.V.
Av. Avila Camacho 2246 · Jardines del Country
MEX-Guadalajara, Jal. 44210
Tel. +52 33 38246787 · Fax +52 33 38531935
e-mail: info@ottobock.com.mx
www.ottobock.com.mx

Otto Bock HealthCare LP
Two Carlson Parkway North, Suite 100
U.S.A.-Minneapolis, Minnesota 55447
Phone +1 800 328 4058 · Fax +1 800 962 2549
e-mail: usa.customerservice@ottobock.com
www.ottobockus.com

Asia/Pacific

Otto Bock Australia Pty. Ltd.
Suite 1.01, Century Corporate Centre
62 Norwest Boulevard · Norwest Business Park
AUS-Baulkham Hills NSW 2153
Tel. +61 2 88182800 · Fax +61 2 88182898
e-mail: healthcare@ottobock.com.au
www.ottobock.com.au

Beijing Otto Bock Orthopaedic Industries Co. Ltd.
HengXiang Tower · No.15 Tuanjiehu South Road
Chaoyang District · Beijing 100026 · P.R.China
Tel. +86 10 85986880 · Fax +86 10 85980040
e-mail: china@ottobock.com.cn · www.ottobock.com.cn

Otto Bock Asia Pacific Ltd.
Suite 3218, 32/F., Sun Hung Kai Centre
30 Harbour Road, Wanchai · Hong Kong
Tel No. +852 2598 9772 · Fax No. +852 2598 7886
e-mail: info@ottobock.com.hk

Otto Bock HealthCare India Pvt. Ltd.
Behind Fairlawn Housing Society
Sion Trombay Road
Chembur · IND-Mumbai 400 071
Tel. +91 22 2520 1268 · Fax +91 22 2520 1267
e-mail: information@indiaottobock.com
www.ottobockindia.com

Otto Bock Japan K. K.
Yokogawa Building 8F · 4-4-44 Shibaura, Minato-ku
J-Tokyo 108-0023
Tel. +81 3 3798-2111 · Fax +81 3 3798-2112
e-mail: ottobock@ottobock.co.jp
www.ottobock.co.jp

Otto Bock Korea HealthCare Inc.
Beekyoung B/D 2FL · 37-22, Samsung-dong
Gangnam-gu · ROK-Seoul 135-090
Tel. +82 2 577-3831 · Fax +82 2 577-3828
e-mail: info@ottobockkorea.com
www.ottobockkorea.com

Otto Bock South East Asia Co. Ltd.
1741 Phaholyothin Road,
Kwaeng Chatuchark, Khet Chatuchark,
T-Bangkok 10900
Tel. +66 2 930 3030 · Fax +66 2 930 3311
e-mail: obsea@ottobock.co.th
www.ottobock.co.th

Other countries

Otto Bock HealthCare GmbH
Max-Näder-Str. 15 · D-37115 Duderstadt
Tel. +49 5527 848-1590 · Fax +49 5527 848-1676
e-mail: reha-export@ottobock.de · www.ottobock.com

Ihr Fachhändler/Your specialist dealer:

Versandanschrift für Rücksendungen/Address for Returns:

Otto Bock Manufacturing Königsee GmbH
Lindenstraße 13 · 07426 Königsee/Germany

Hersteller/Manufacturer:

Otto Bock Mobility Solutions GmbH
Lindenstraße 13 · 07426 Königsee/Germany
Phone +49 69 9999 9393 · Fax +49 69 9999 9392
ccc@ottobock.com · www.ottobock.com



Otto Bock Mobility Solutions GmbH has been certified by the German Society for the Certification of Quality Assurance Systems (DQS) in accordance with DIN EN ISO 9001 standard, reg. no. 779 (management system)